



SHADOW™ with Stealth Technology®
0.8 GPF Single Flush Toilet Round ADA Bowl with 12" Rough-in



SHADOW™

0.8 GPF SINGLE FLUSH TOILET

Round ADA Bowl with 12" Rough-in

FEATURES & SPECIFICATIONS

- Exclusive PRO Product
- Preassembled tank for quick installation
- 15 Year Warranty**
- MaP Score 800g
- Fluidmaster® PRO Fill Valve
- Equipped with Stealth Technology® PRO Vessel
- Left or right color match zinc handle
- Thin modern tank design
- ADA Height

CERTIFICATIONS



Materials: Vitreous China **Finish Color:** White

Codes/Standards:

ASME A112.19.2/CSA B45.1

DOE - Energy Policy Act 1992

California Energy Commission (CEC)

CALGreen Compliant

ICC/ANSI A117.1

MEASUREMENTS

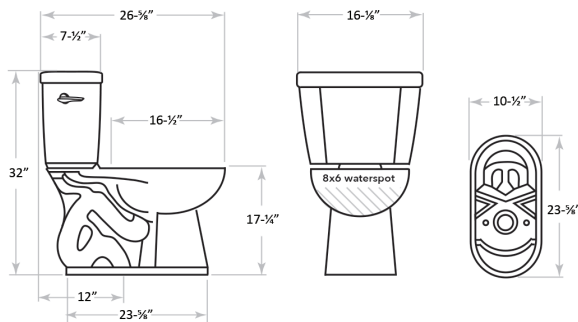

BULK PACKAGING

C33.200.01 Left Combo

C33.201.01 Right Combo

33.0200.01 Round Bowl

UPC Code 732291332026

Packaging Type Kraft Corrugated

Packaging Dimensions 15.8" W
17.6" H
26.6" D

Packaging Weight 49.34

Skid Quantity 12 or 18

33.0300.01LWH Tank (Left)

33.0300.01RWH Tank (Right)

UPC Code Left 732291333009

UPC Code Right 732291333016

Packaging Type Kraft Corrugated

Packaging Dimensions 8.46" W
16.73" H
16.8" D

Packaging Weight 36.44

Skid Quantity 30

**LIMITED LIFETIME WARRANTY on vitreous china products. Toilet tank trim: fill valve and flush valve assembly and plumbing fittings are warranted for a period of fifteen (15) years to the purchaser from the date of purchase. Call Niagara for complete warranty details.