



## **BARRON™**

**1.0 GPF Pressure Assist Toilet** Elongated ADA Bowl with 10" Rough-in



# BARRON™

## 1.0 GPF PRESSURE ASSIST TOILET

Elongated ADA Bowl with 10" Rough-in

### FEATURES & SPECIFICATIONS

- Powerful pressure assist flush technology
- Upgraded brass bolt set
- Chrome left and right handle options
- MaP Score 1000g
- Extra large water spot for a clean bowl
- Fully glazed trapway for easy waste removal
- ADA Height

### CERTIFICATIONS



**Materials:** Vitreous China **Finish Color:** White

#### Codes/Standards:

ASME A112.19.2/CSA B45.1

DOE - Energy Policy Act 1992

California Energy Commission (CEC)

CALGreen Compliant

ICC/ANSI A117.1

### MEASUREMENTS

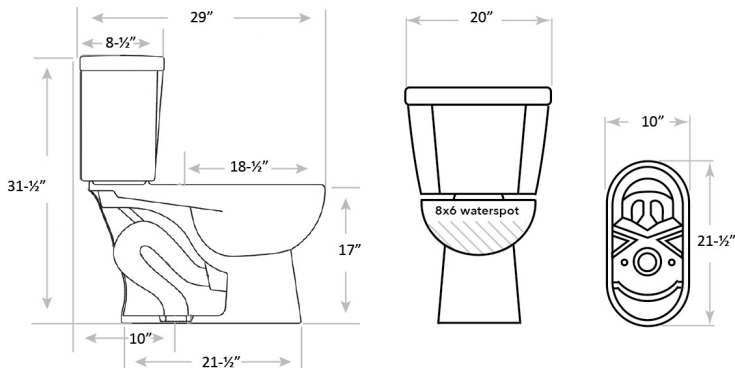

### BULK PACKAGING

**C44.310.01** Left Combo  
**C44.311.01** Right Combo

**44.0203.01** Elongated Bowl

UPC Code 732291442039

Packaging Type Kraft Corrugated

Packaging Dimensions 15.7" W  
18.6" H  
29.1" D

Packaging Weight 50.95

Skid Quantity 12 or 18

**44.0300.01LWH** Tank (Left)  
**44.0300.01RWH** Tank (Right)

UPC Code Left 732291443005

UPC Code Right 732291443012

Packaging Type Kraft Corrugated

Packaging Dimensions 10.4" W  
10.4" H  
21.3" D

Packaging Weight 43.61

Skid Quantity 30

\*\*LIMITED LIFETIME WARRANTY on vitreous china products. Toilet tank trim: fill valve and flush valve assembly and plumbing fittings are warranted for a period of fifteen (15) years to the purchaser from the date of purchase. Call Niagara for complete warranty details.