



SABRE™ with Stealth Technology®

1.28 GPF Single Flush Toilet Round Bowl with 12" Rough-in



SABRE™ with Stealth Technology®

1.28 GPF SINGLE FLUSH TOILET

Round Bowl with 12" Rough-in

FEATURES & SPECIFICATIONS

- Patented Stealth Technology®
- MaP Score 1000g
- Upgraded Brass Bolt Set
- Custom 400A Fluidmaster® Fill Valve
- Left and right handle available
- Large water spot and 360° rim wash ensures clean bowl
- Extra large footprint

CERTIFICATIONS



Materials: Vitreous China **Finish Color:** White

Codes/Standards:

- ASME A112.19.2/CSA B45.1
- DOE - Energy Policy Act 1992
- California Energy Commission (CEC)
- CalGreen Compliant

MEASUREMENTS

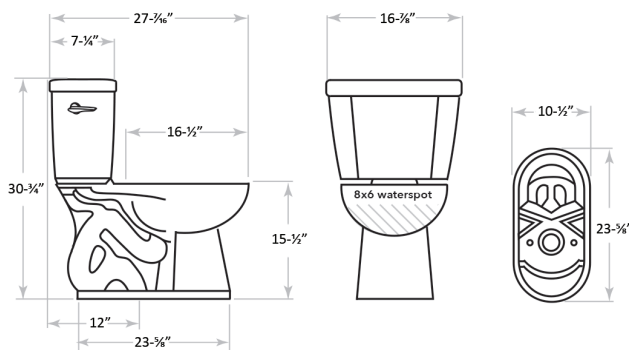

BULK PACKAGING

C22.002.01 Left Combo
C22.003.01 Right Combo

22.0202.01 Round Bowl

UPC Code 732291222020

Packaging Type Kraft Corrugated

Packaging Dimensions 15.6" W
15.9" H
26.6" D

Packaging Weight 47.58

Skid Quantity 12 or 18

22.0301.01 Tank (Left)
22.0301.01 Tank (Right)

UPC Code Left 732291223102

UPC Code Right 732291223119

Packaging Type Kraft Corrugated

Packaging Dimensions 8.46" W
16.73" H
16.8" D

Packaging Weight 36.44

Skid Quantity 30

**LIMITED LIFETIME WARRANTY on vitreous china products. Toilet tank trim: fill valve and flush valve assembly and plumbing fittings are warranted for a period of fifteen (15) years to the purchaser from the date of purchase. Call Niagara for complete warranty details.